

Hiipakka

- Since 1951 -



MEKANISMIT KORIT





VITI LANKAKORIT

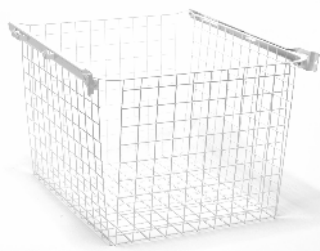

Koodi	Tuote	Pituus	Leveys	Korkeus	Väri
45700	400/150	500 mm	337 mm	150 mm	Valkoinen
45702	400/300	500 mm	337 mm	300 mm	Valkoinen
45704	500/150	500 mm	437 mm	150 mm	Valkoinen
45706	500/300	500 mm	437 mm	300 mm	Valkoinen
45708	600/150	500 mm	537 mm	150 mm	Valkoinen
45710	600/300	500 mm	537 mm	300 mm	Valkoinen
45712	800/150	500 mm	737 mm	150 mm	Valkoinen

Valkoinen teräs lankakori. 16 mm runkovahvuudelle.

STARAX[®] HENKARILIUKU



Koodi	Pituus	Väri
45994	300 mm	Kromi/Harmaa
45995	350 mm	Kromi/Harmaa
45996	400 mm	Kromi/Harmaa
45997	450 mm	Kromi/Harmaa

Teräs / harmaa muovi.

STARAX®



PLEXIKORI



Koodi	Tuote	Pituus	Leveys	Korkeus	Väri
45945	60 pexikori	460 mm	560-590 mm	170 mm	Valkoinen
45947	80 plexikori	460 mm	760-790 mm	170 mm	Valkoinen

Valkoinen alumiini. Hidastavat kiskot.

HOUSUTELINE



Koodi	Tuote	Pituus	Leveys	Korkeus	Väri
45933	60 housuteline	460 mm	560-590 mm	150 mm	Valkoinen
45935	80 housuteline	460 mm	760-790 mm	150 mm	Valkoinen

Valkoinen alumiini. Hidastavat kiskot.

KORITELINE



Koodi	Kätisyys	Pituus	Leveys	Korkeus	Väri
45925	Vasen	460 mm	325 mm	960 mm	Valkoinen
45926	Oikea	460 mm	325 mm	960 mm	Valkoinen

Valkoinen alumiini. Plexi-seinät. Hidastavat kiskot. Irrotettavat korit.



HENKARILIUKU

Koodi	Tuote	Pituus	Leveys	Korkeus	Väri
45920	Henkariliuku	460 mm	120 mm	135 mm	Valkoinen



KENKÄTELINE

Koodi	Tuote	Pituus	Leveys	Korkeus	Väri
45940	Kenkäteline	500 mm	600 mm	250 mm	Valkoinen
45942	Kenkäteline	500 mm	800 mm	250 mm	Valkoinen



KORI/HOUSUTELINE

Koodi	Kätisyys	Pituus	Leveys	Korkeus	Väri
45922	Vasen	460	220	360	Valkoinen
45923	Oikea	460	220	360	Valkoinen

SILITYSLAUTAMEKANISMI



Koodi	Tuote	Väri
45930	Silityslautamekanismi	Harmaa

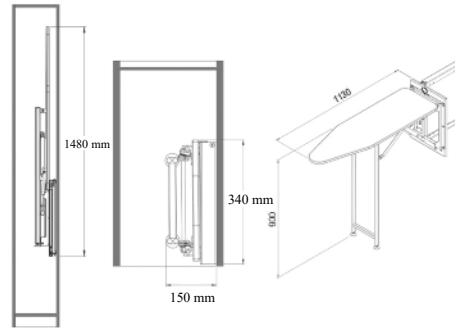

SILITYSLAUTAMEKANISMI

TULOSSA UUSI
MALLI





SMOOTH

Piilokulmamekanismi

- Helppo ja nopea asentaa
- Kolme ovileveyttä 395, 445 ja 495 mm

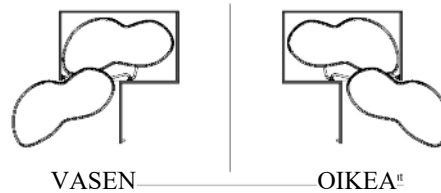

Koodi	Nimike	Lisänimike	C
45892	Starax Piilokulmamekanismi SMOOTH	40cm S3103 VASEN	400 mm
45893	Starax Piilokulmamekanismi SMOOTH	40cm S3104 OIKEA	400 mm
45900	Starax Piilokulmamekanismi SMOOTH	45cm S3013 VASEN	450 mm
45901	Starax Piilokulmamekanismi SMOOTH	45cm S3014 OIKEA	450 mm
45894	Starax Piilokulmamekanismi SMOOTH	50cm S3113 VASEN	500 mm
45895	Starax Piilokulmamekanismi SMOOTH	50cm S3114 OIKEA	500 mm

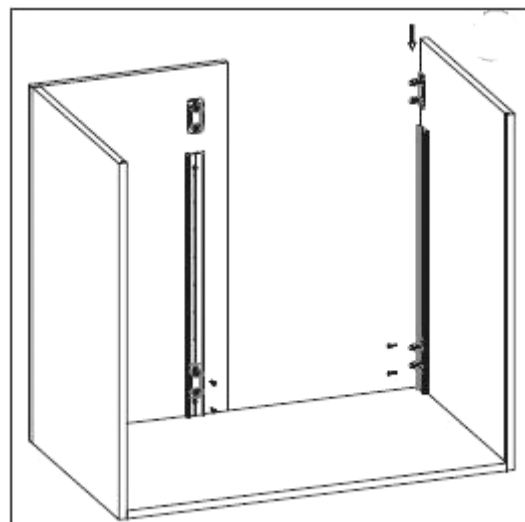
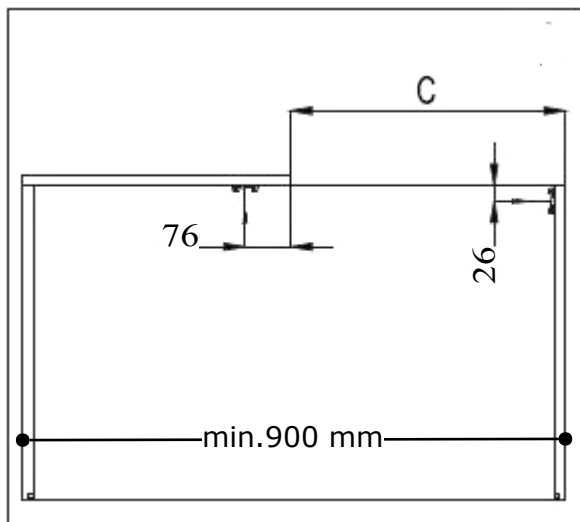

KULMAKAAPIN HYLLYT

STARAX®



KARUSELLI 3/4

Koodi	Tuote	Halk.	Kork.
45904	WING 3/4 karuselli	750 mm	600 mm

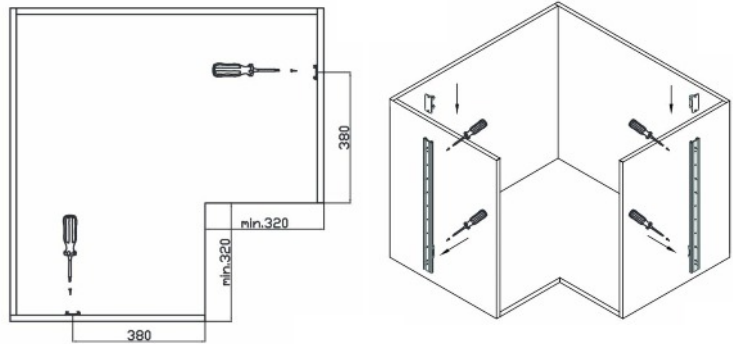

KARUSELLI 3/4

Koodi	Tuote	Halk.
05846	3/4 karuselli pohjakiinnitys	720 mm
05848	3/4 karuselli pohjakiinnitys	820 mm
05850	3/4 karuselli ylä- ja alakiinnitys	820 mm

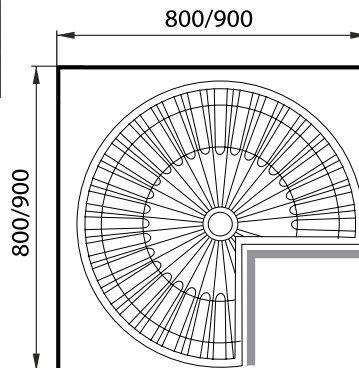

SECRET



Koodi	Leveys	Korkeus	Min.aukko	Kätisyys
45905	890-960 mm	530 mm	350 mm	Vasen
45906	890-960 mm	530 mm	350 mm	Oikea

Teräs kromattu. Hidastavat kiskot.
890-960 x 530 x 350 mm.

GRANDE



Koodi	Halk.	Korkeus	Väri
45903	800 mm	640-700 mm	Kromi

Kromattu teräs.
Halk. 800 mm x 640-700.

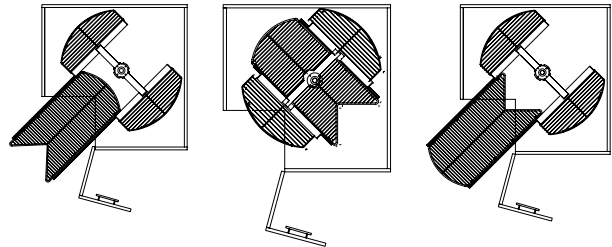



20 TARVIKEVAUNU

Koodi	Tuote	Leveys	Syvyys	Korkeus	Väri
45912	Tarvikevaunu	151 mm	475 mm	495 mm	Kromi



30 TARVIKEVAUNU/PYYHETELINEELLÄ

Koodi	Tuote	Kätisyys	Pituus	Leveys	Korkeus	Väri
45914	Tarvikevaunu	Oikea	475 mm	203 mm	640 mm	Kromi
45915	Tarvikevaunu	Vasen	475 mm	203 mm	640 mm	Kromi



OHITUSKORI

Koodi	Tuote	Pituus	Leveys	Korkeus	Väri
45955	Ohituskori	500 mm	600 mm	100 mm	Kromi
45956	Ohituskori	500 mm	800 mm	100 mm	Kromi
45954	Etusarjan kiinnike				Kromi



VETOKORI

Koodi	Tuote	Pituus	Leveys	Korkeus	Väri
45950	40 vetokori	500 mm	400 mm	100 mm	Kromi
45951	50 vetokori	500 mm	500 mm	100 mm	Kromi
45952	60 vetokori	500 mm	600 mm	100 mm	Kromi
45953	80 vetokori	500 mm	800 mm	100 mm	Kromi
45954	Etusarjan kiinnike				Kromi

Teräs kromattu. Täysin ulostuleva. 15-20 mm runkovahvuudelle.
Voidaan asentaa myös saranaoven taakse. Tandem kiskot.



UUNIPELTIMEKANISMI



Koodi	Leveys	Syvyys	Väri
05270UPM	600 mm	450 mm	Sinkitty



Sinkitty teräs. Täysin ulostuleva. Hidastavalla kiskolla. Uunipeltiin on valmiiksi kiinnitetyt kiskot. Kiskot poistetaan avaamalla kiinnitysruuvit.

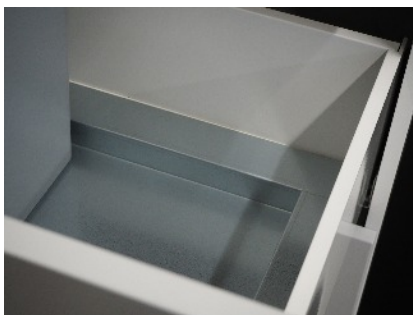
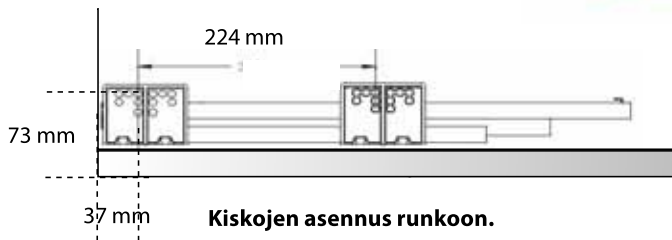

Madalluspohjan avulla saadaan laatikon korkeus mahdollisimman korkeaksi. Esim. 350 korkean etusarjan taakse mahtuu nyt korkeampikin jäteastia.

MADALLUSPOHJA MAGIC PRO-laatikoihin

- Esim. jätevaunuun
- Helppo asentaa
- Sinkitty teräs + asennuspalat
- Leveydet 40,50,60,70 ja 80 cm
- Syvyys 45 cm

Koodi	Nimike
42950	Magic Pro 40/45 madalluspohja sinkitty
42951	Magic Pro 50/45 madalluspohja sinkitty
42952	Magic Pro 60/45 madalluspohja sinkitty
42953	Magic Pro 70/45 madalluspohja sinkitty
42954	Magic Pro 80/45 madalluspohja sinkitty

ASTIANKUIVAUSHYLLYT

LAUTASRITILÄ



Koodi	Leveys	Syvyys cc mm	Pakk.
05808M	363 mm	260 mm	10 kpl
05809M	463 mm	260 mm	10 kpl
05810M	563 mm	260 mm	10 kpl
05811M	663 mm	260 mm	10 kpl
05812M	763 mm	260 mm	10 kpl
05813M	863 mm	260 mm	10 kpl
05814M	963 mm	260 mm	10 kpl

TASORITILÄ



Koodi	Leveys	Syvyys cc mm	Pakk.
05800M	363 mm	260 mm	10 kpl
05801M	463 mm	260 mm	10 kpl
05802M	563 mm	260 mm	10 kpl
05803M	663 mm	260 mm	10 kpl
05804M	763 mm	260 mm	10 kpl
05805M	863 mm	260 mm	10 kpl
05806M	963 mm	260 mm	10 kpl

KANNATINLISTA RITILÄHYLLYLLE

Säädettävä



Koodi	Pituus	Väri
05817M	267 mm	Harmaa

RITILÄN KANNATIN



Koodi	Halk.	Väri
04955	5 mm	Valkoinen
04910	5 mm	Harmaa

KUIVAUSKAAPIN SIDELISTA



DIA 8 mm
cc 32 mm

Koodi	Pituus mm	Materiaali	Väri
35490	367	Alumiini	Valkoinen
35491	467	Alumiini	Valkoinen
35492	567	Alumiini	Valkoinen
35493	667	Alumiini	Valkoinen
35494	767	Alumiini	Valkoinen
39495	867	Alumiini	Valkoinen
35496	967	Alumiini	Valkoinen

ASTIANKUIVAUSHYLLYT

RST-TASOHYLLY



Koodi	Leveys	Syvyys cc mm	Pakk.
05820T04	400 mm	226 mm	4 kpl
05820T05	500 mm	226 mm	4 kpl
05820T06	600 mm	226 mm	4 kpl
05820T07	700 mm	226 mm	4 kpl
05820T08	800 mm	226 mm	4 kpl
05820T09	900 mm	226 mm	4 kpl
05820T10	1000 mm	226 mm	4 kpl

RST-LAUTASHYLLY

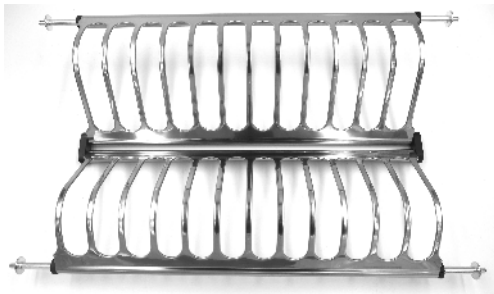

Koodi	Leveys	Syvyys cc mm	Pakk.
05820L04	400 mm	226 mm	4 kpl
05820L05	500 mm	226 mm	4 kpl
05820L06	600 mm	226 mm	4 kpl
05820L07	700 mm	226 mm	4 kpl
05820L08	800 mm	226 mm	4 kpl
05820L09	900 mm	226 mm	4 kpl
05820L10	1000 mm	226 mm	4 kpl

RST-VALUTUSALLAS



Koodi	Leveys	Syvyys cc mm	Pakk.
05820V04	400 mm	226 mm	4 kpl
05820V05	500 mm	226 mm	4 kpl
05820V06	600 mm	226 mm	4 kpl
05820V07	700 mm	226 mm	4 kpl
05820V08	800 mm	226 mm	4 kpl
05820V09	900 mm	226 mm	4 kpl
05820V10	1000 mm	226 mm	4 kpl

JÄTEVAUNUT JA TARVIKKEET



JÄTEVAUNU 4428 2x10L

Koodi	Korkeus	Syvyys	Korkeus	Väri
05865M2	265 mm	450 mm	350 mm	Harmaa



JÄTEVAUNU 4130 2x10 L +5 L

Koodi	Korkeus	Syvyys	Korkeus	Väri
05865M3	265 mm	450 mm	350 mm	Harmaa



JÄTEVAUNU 4140 2x10 L

Koodi	Leveys	Syvyys	Korkeus	Väri
05865M2A	180 mm	450 mm	350 mm	Harmaa



Valitse sopivat sangot.

JÄTEVAUNU XXL POHJA

Koodi	Leveys	Syvyys	Väri
05866P3	257 mm	450 mm	Harmaa

Sankokartta

5	5	5	10
5		10	
15	20	10	15

JÄTEVAUNUT JA TARVIKKEET

JÄTÄRI JÄTEVAUNUMEKANISMI



Koodi	Leveys	Syvyys	Väri
45884	400 mm	450 mm	Harmaa
45885	500 mm	450 mm	Harmaa
45886	600 mm	450 mm	Harmaa
45888	800 mm	450 mm	Harmaa

Ilman sankoja.



LAJITTELUKEHÄ 400

KoodiM	Korkeus	Syvyys	Leveys	Väri
05863M04	20 mm	450	400	Harmaa
05863m04V	20 mm	450	400	Valkoinen

Sankovaihtoehdot esim. 1x21I, 2x10I, 1x10I+2x5I tai 4x5I. Väri harmaa.



LAJITTELUKEHÄ 500

KoodiM	Korkeus	Syvyys	Leveys	Väri
05863M05	20 mm	450	500	Harmaa
05863M05V	20 mm	450	500	Valkoinen

Sankovaihtoehdot esim. 1x21I+14I, 2x10I+14I, 1x10I+2x5I+14I tai 4x5I+14I. Väri harmaa.



LAJITTELUKEHÄ 600

KoodiM	Korkeus	Syvyys	Leveys	Väri
05863M06	20 mm	450	600	Harmaa
05863M06	20 mm	450	600	Valkoinen

Sankovaihtoehdot esim. 2x21I, 2x10I+21I, 1x10I+2x5I+21I tai 4x5I+21I. Väri harmaa.

JÄTEVAUNUT JA TARVIKKEET

LAJITTELUKEHÄ 800

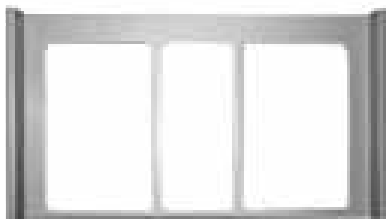

KoodiM	Korkeus	Syvyys	Leveys	Väri
05863M08	20 mm	450	800	Harmaa
05863M08V	20 mm	450	800	Valkoinen

Sankovaihtoehdot esim. 2x21I+12I, 2x10I+21I+14I, 3x10I+2x5I, 21I+14I tai 4x10I + 14I. Väri harmaa.

SANKOKARTTA JÄTÄRIIN JA LAJITTELUKEHIIN

40

50

60

80

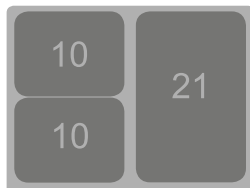
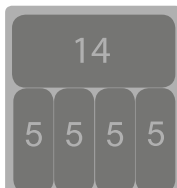
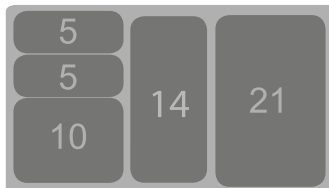
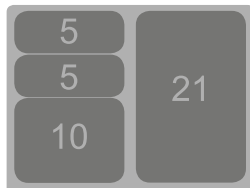
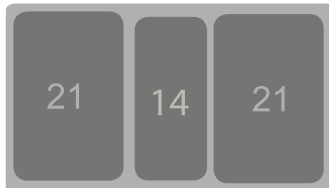
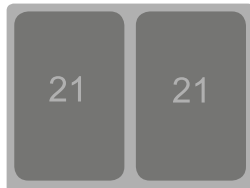
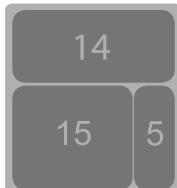
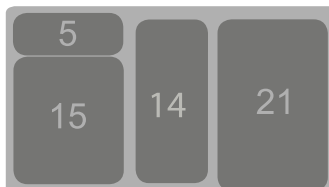
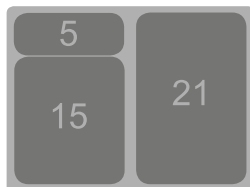
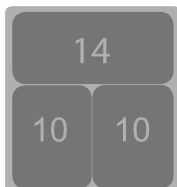
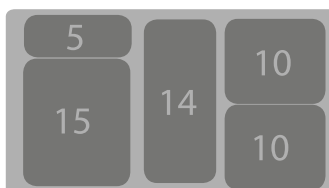
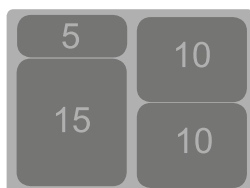
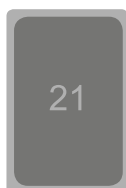

JÄTEVAUNUT JA TARVIKKEET



ALLASKAAPIN POHJAMUOVI

Koodi	Kaapin lev.	Leveys	Väri
05835	600 mm	566 mm	Harmaa
05836	800 mm	766 mm	Harmaa
05837	1000 mm	966 mm	Harmaa



JÄTESANKO 5L

Koodi	Korkeus	Syvyys	Leveys	Väri
05864M05	290 mm	230 mm	90mm	Harmaa



JÄTESANKO 10L

Koodi	Korkeus	Syvyys	Leveys	Väri
05864M10	290 mm	230 m	190 mm	Harmaa
05864M10+	Kansi			Harmaa



JÄTESANKO 14L

Koodi	Korkeus	Syvyys	Leveys	Väri
05864M14	290 mm	358 m	160 mm	Harmaa

JÄTEVAUNUT JA TARVIKKEET



JÄTESANKO 15 L

Koodi	Korkeus	Syvyys	Leveys	Väri
05864M15	290 mm	270 mm	230 mm	Harmaa



JÄTESANKO 21 L

Koodi	Korkeus	Syvyys	Leveys	Väri
05864M21	290 mm	358 m	230 mm	Harmaa



JÄTEAUKON KAULUS

Koodi	Ulkohalk.	Reiän halk.	Korkeus	Väri
06491	140	117 mm	100 mm	Hiottu RST

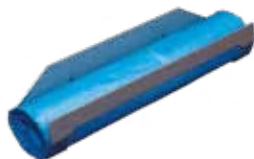

PUSSITELINE

Koodi	Leveys	Syvyys	Korkeus	Väri
05866PST	260 mm	70 mm	70 mm	Hopea



ONGELMAJÄTESANKO

Koodi	Leveys	Syvyys	Korkeus	Väri
05866OJS	230 mm	90 mm	290 mm	Punainen

SIIVOUSKOMEROTELINEET

SIIVOUSVÄLINESETTI



Koodi	Leveys	Syvyys	Korkeus	Väri
05912M	420 mm	150 mm	1140 mm	Hopea

SIIVOUSTARVIKETELINE



Koodi	Leveys	Syvyys	Korkeus	Väri
05911	420 mm	150 mm	650 mm	Hopea

IMURIN LETKUKAARI HYLLYLLÄ



Koodi	Leveys	Syvyys	Korkeus	Väri
05909	420 mm	150 mm	300 mm	Hopea

IMURIN LETKUKAARI



Koodi	Leveys	Syvyys	Korkeus	Väri
05910	420 mm	150 mm	200mm	Hopea

Hiipakka

– Since 1951 –

www.ejh.fi

E J Hiipakka Oy
Teollisuustie 1
66300 JURVA

020 76 89 530