

# Hiipakka

- Since 1951 -

# Solo

# Siro

## Vitriini

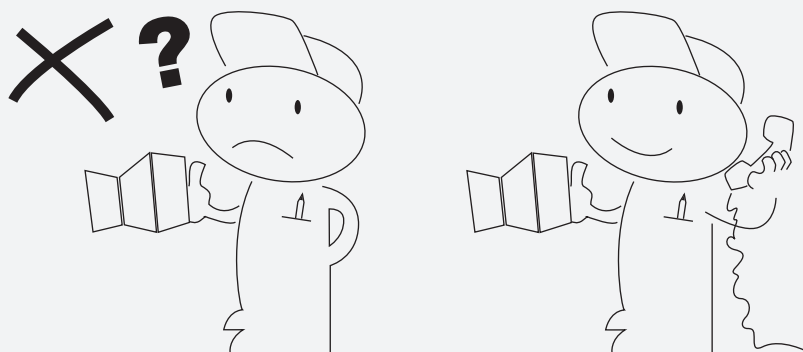
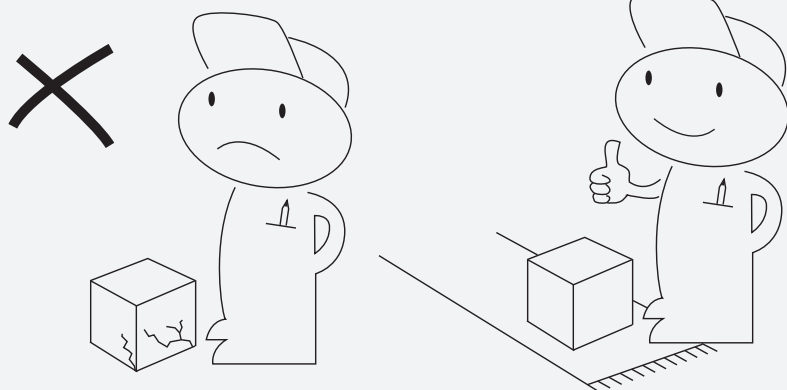
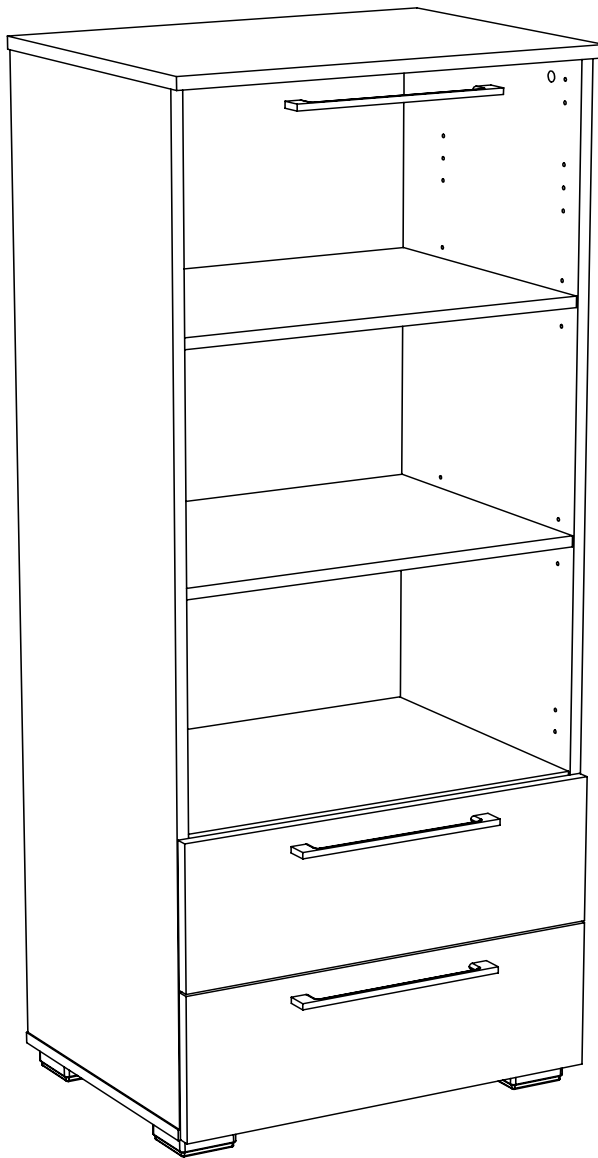









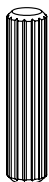

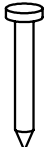
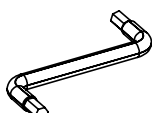
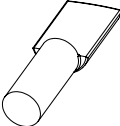
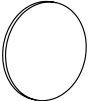
[www.hiipakka.net](http://www.hiipakka.net)  
Phone: +358 20 7689 500

E J Hiipakka Oy  
Teollisuustie 1  
FI - 66300 JURVA, FINLAND

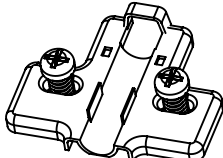
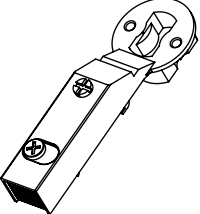
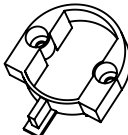
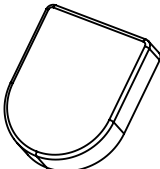

# Pusseissa / i påsar / in bags

18 x	8 x	8 x	~50 x
			
1 x	8 x	6 x	4 x
			

2 x	2 x	2 x	2 x	4 x
				
2 x	8 x	24 x	2 x	
				

## Solo

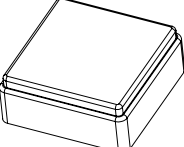
8 x	4 x
	

TOČĀ  
ÒŠŠÒÛ

## Siro

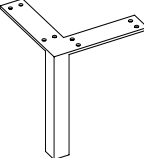
32 x	4 x
	

x 4



x 6

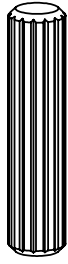

F

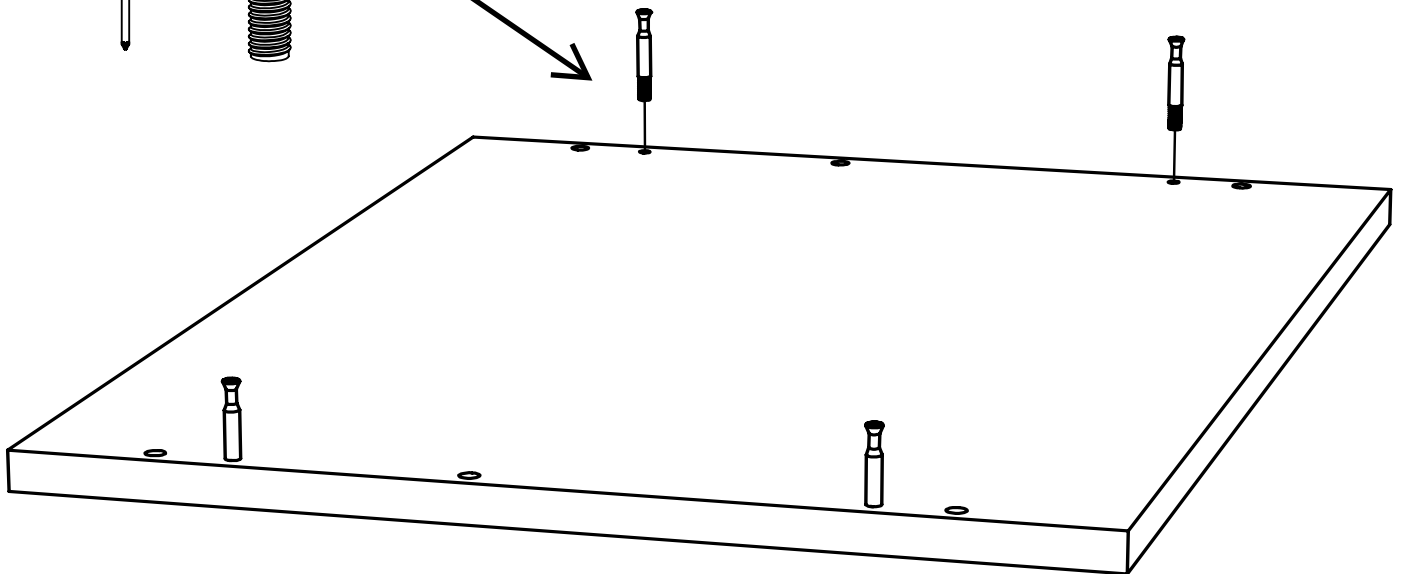
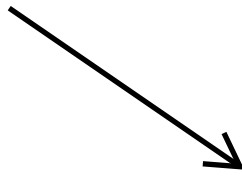
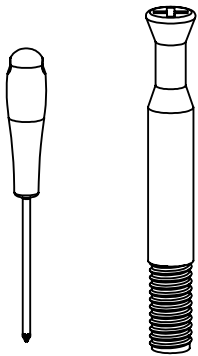
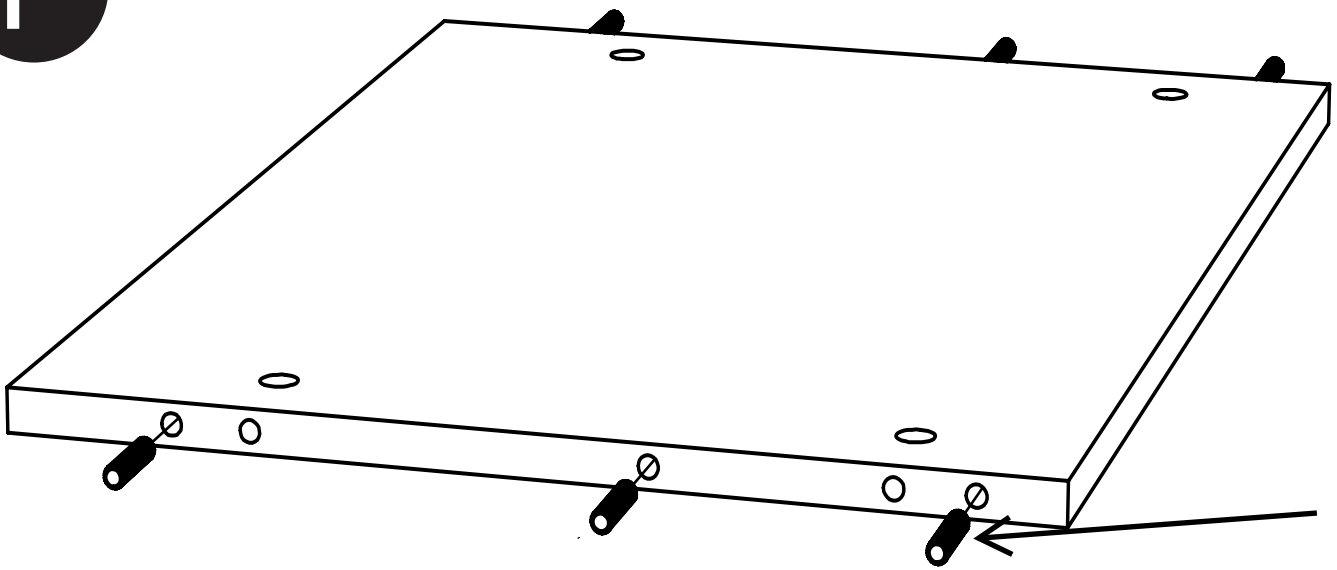

x 12



x 4



**G**

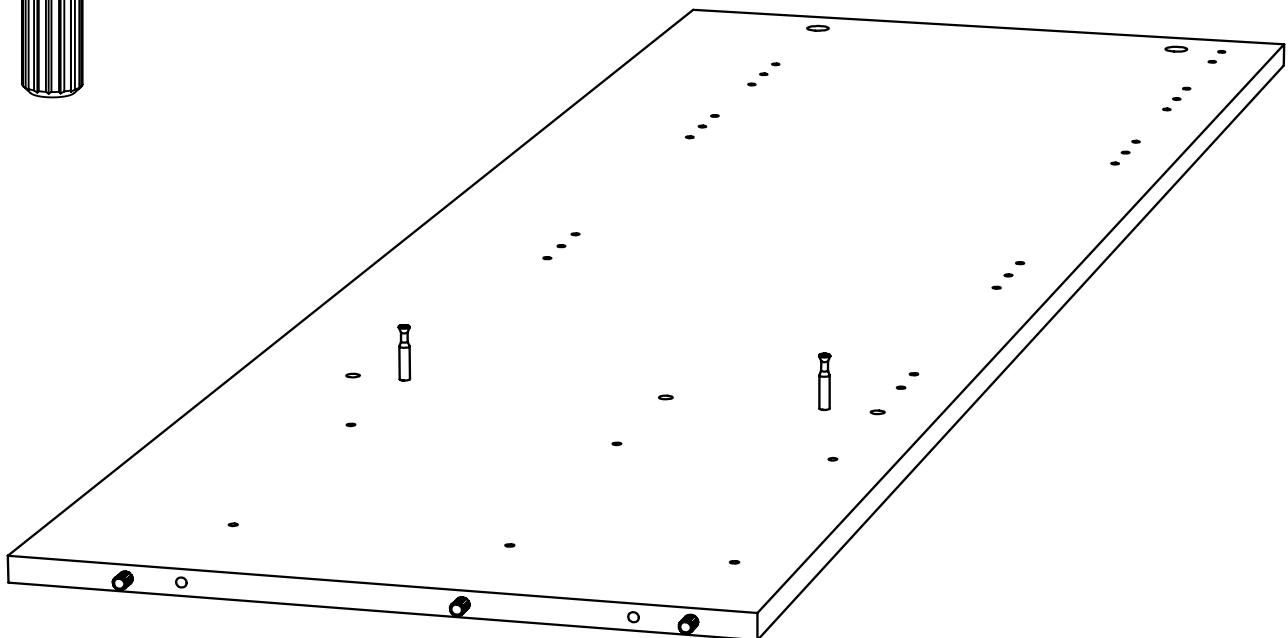
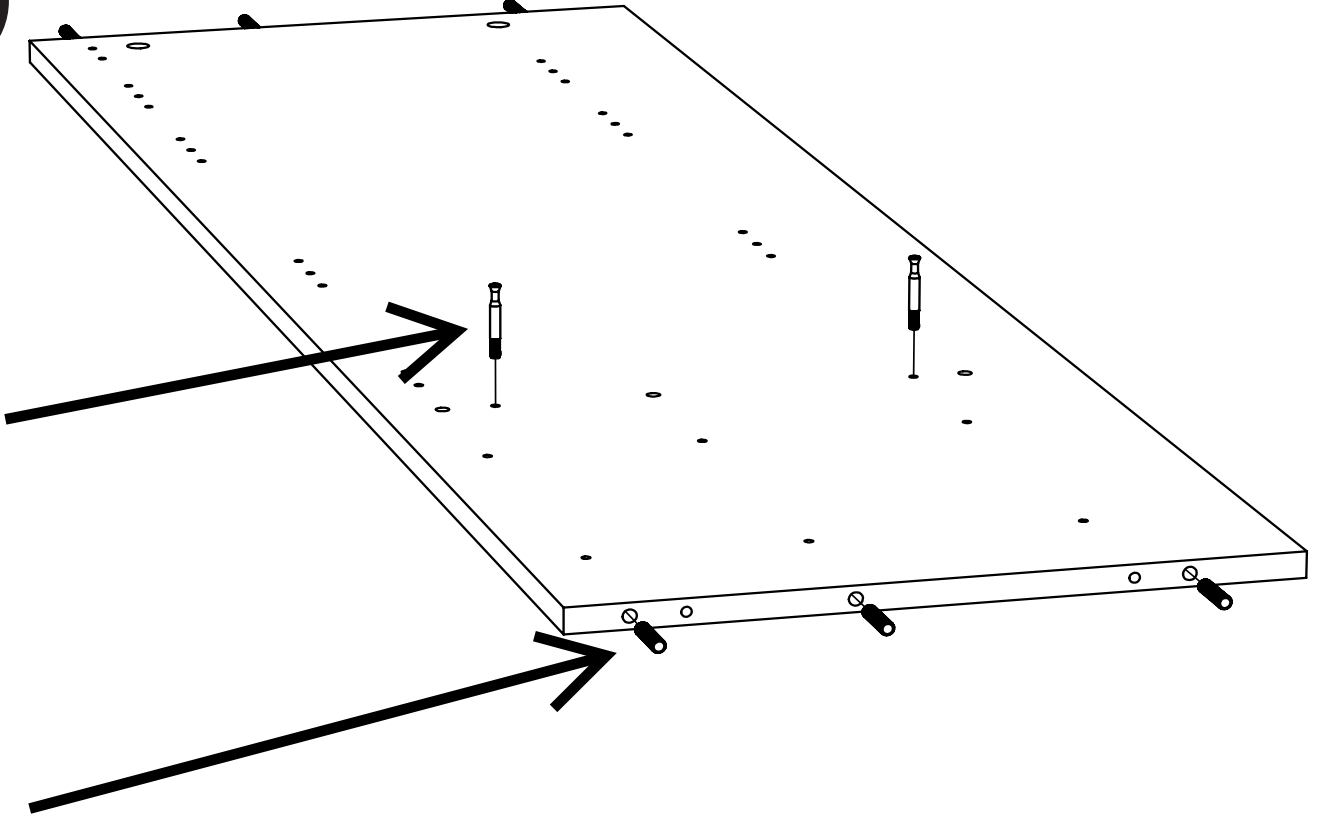
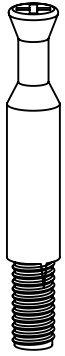
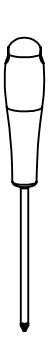

x 4

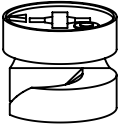

H

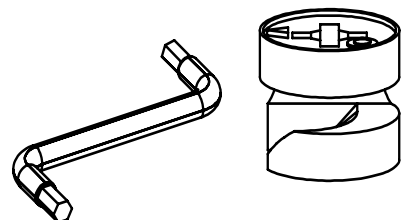
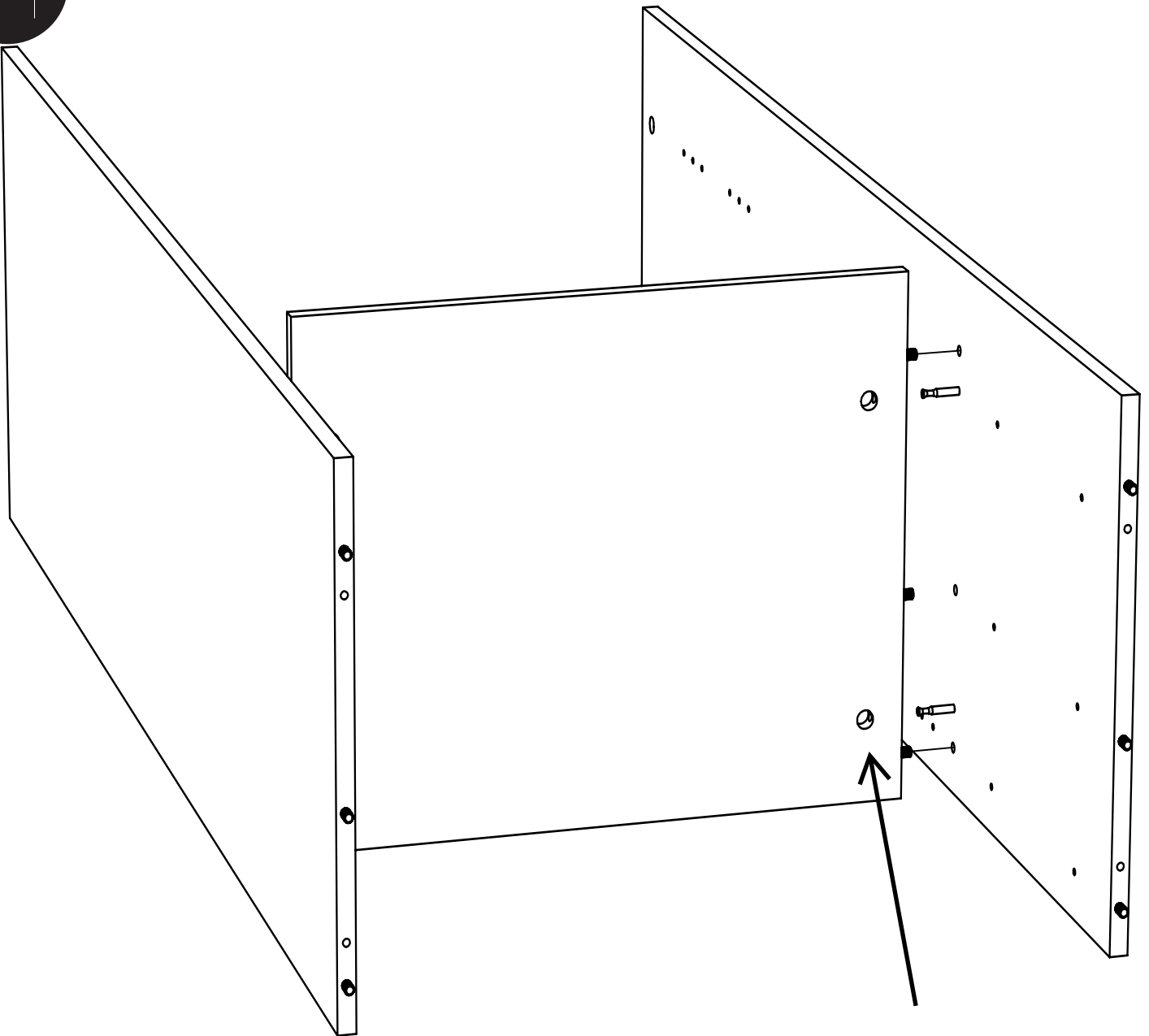

x 4



x 4

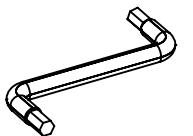
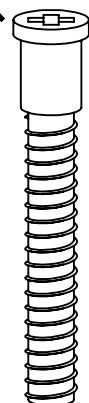
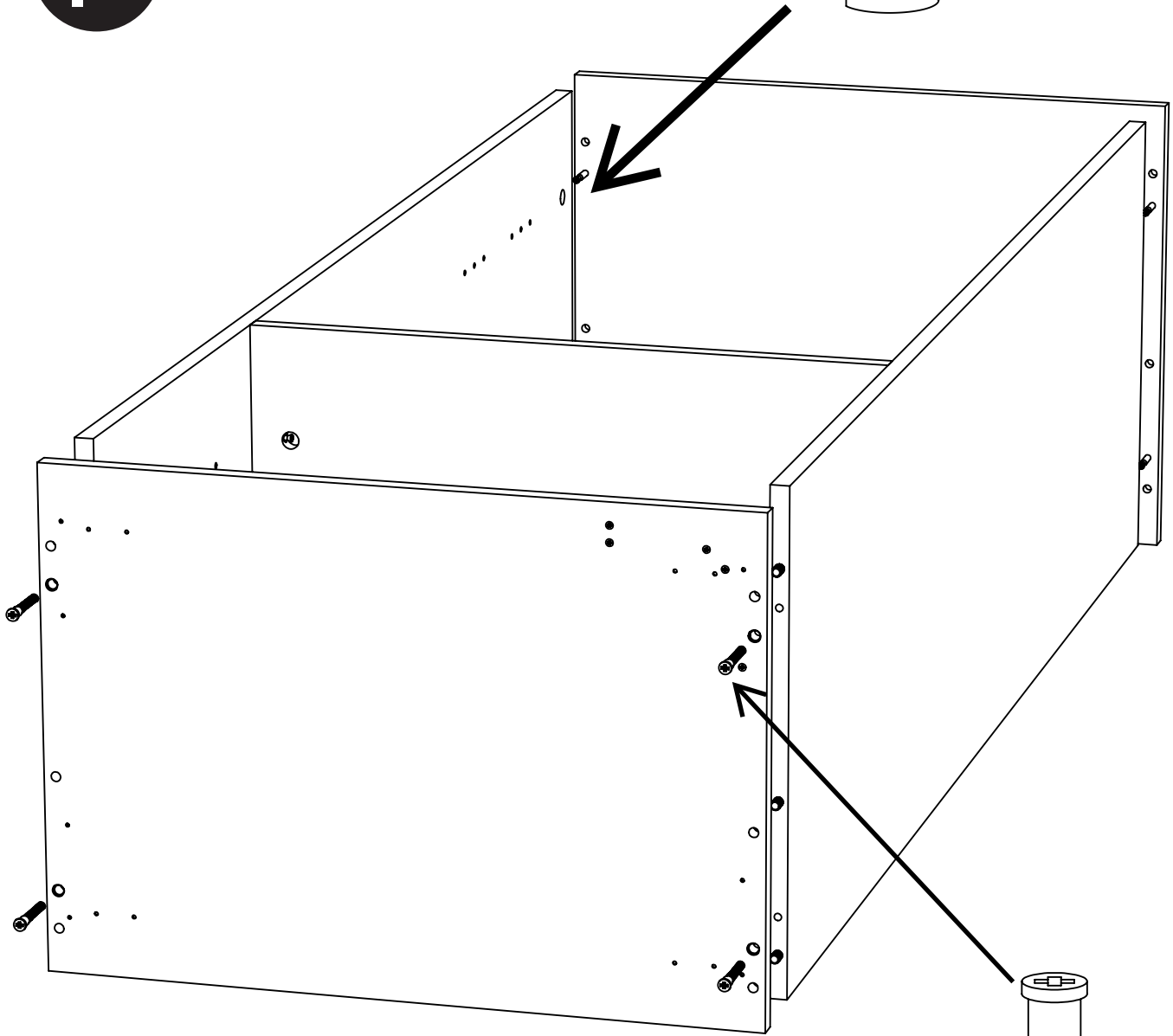
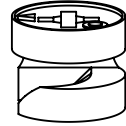
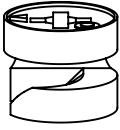

Solo



x 8

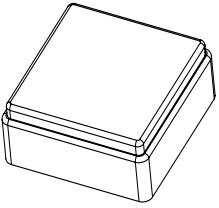

x 4

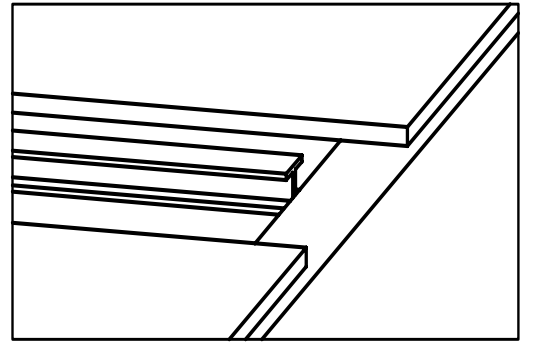

5

Tarkista ristimita  
Kontrollera kryssmättet  
Check the crosswise measure

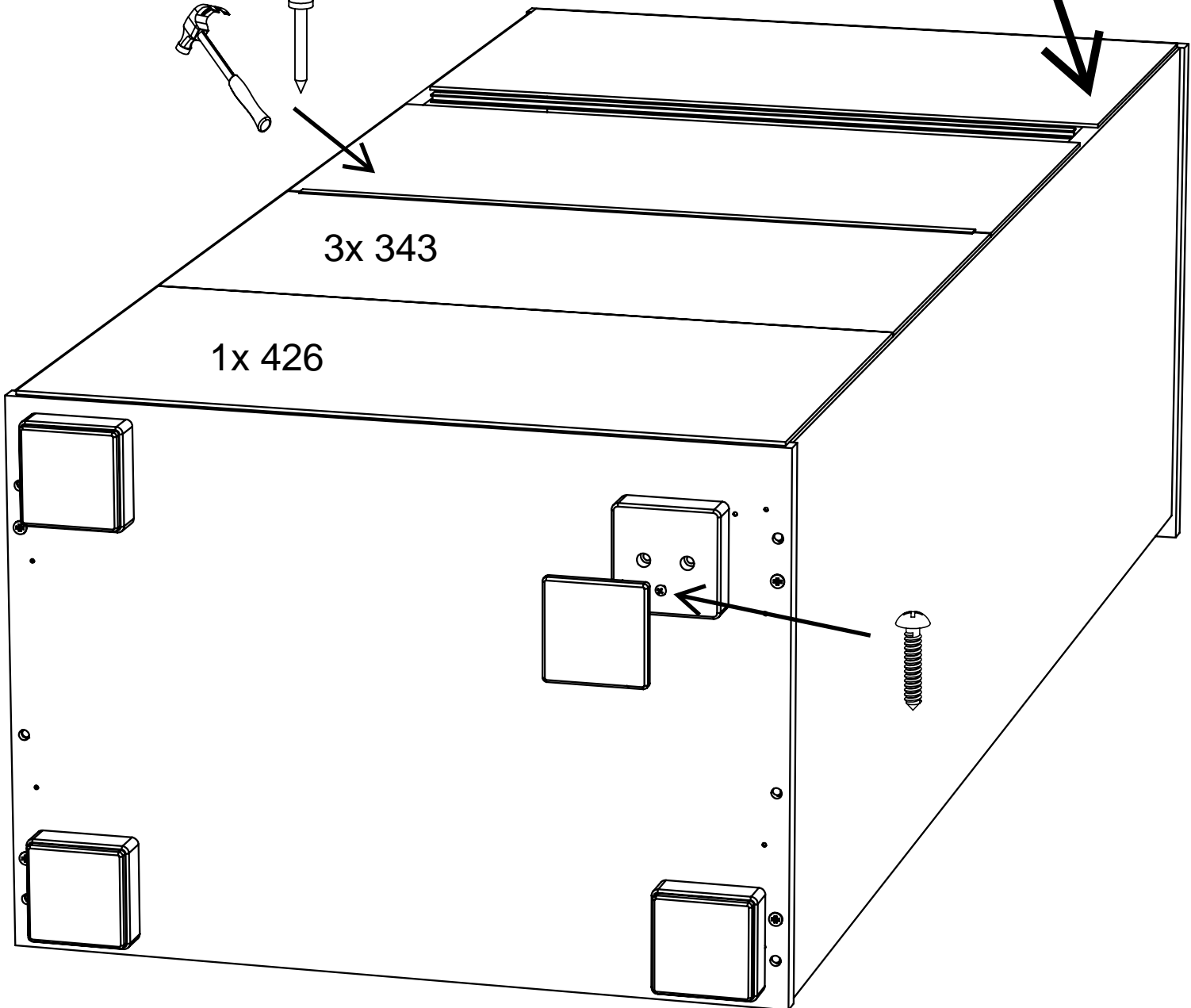
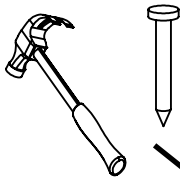

# Siro



x 32

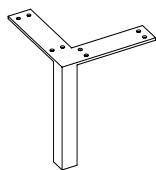

x 4

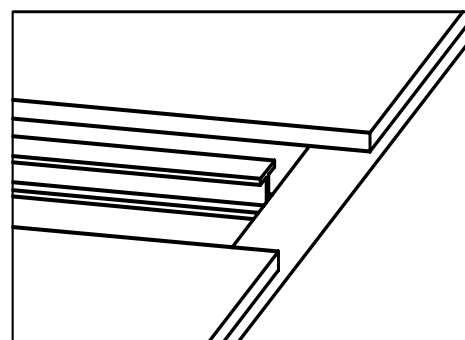

## 6

Tarkista ristimitta  
Kontrollera kryssmättet  
Check the crosswise measure

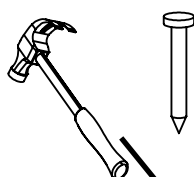

3x 343

1x 426

vain 2  
merkkireikä

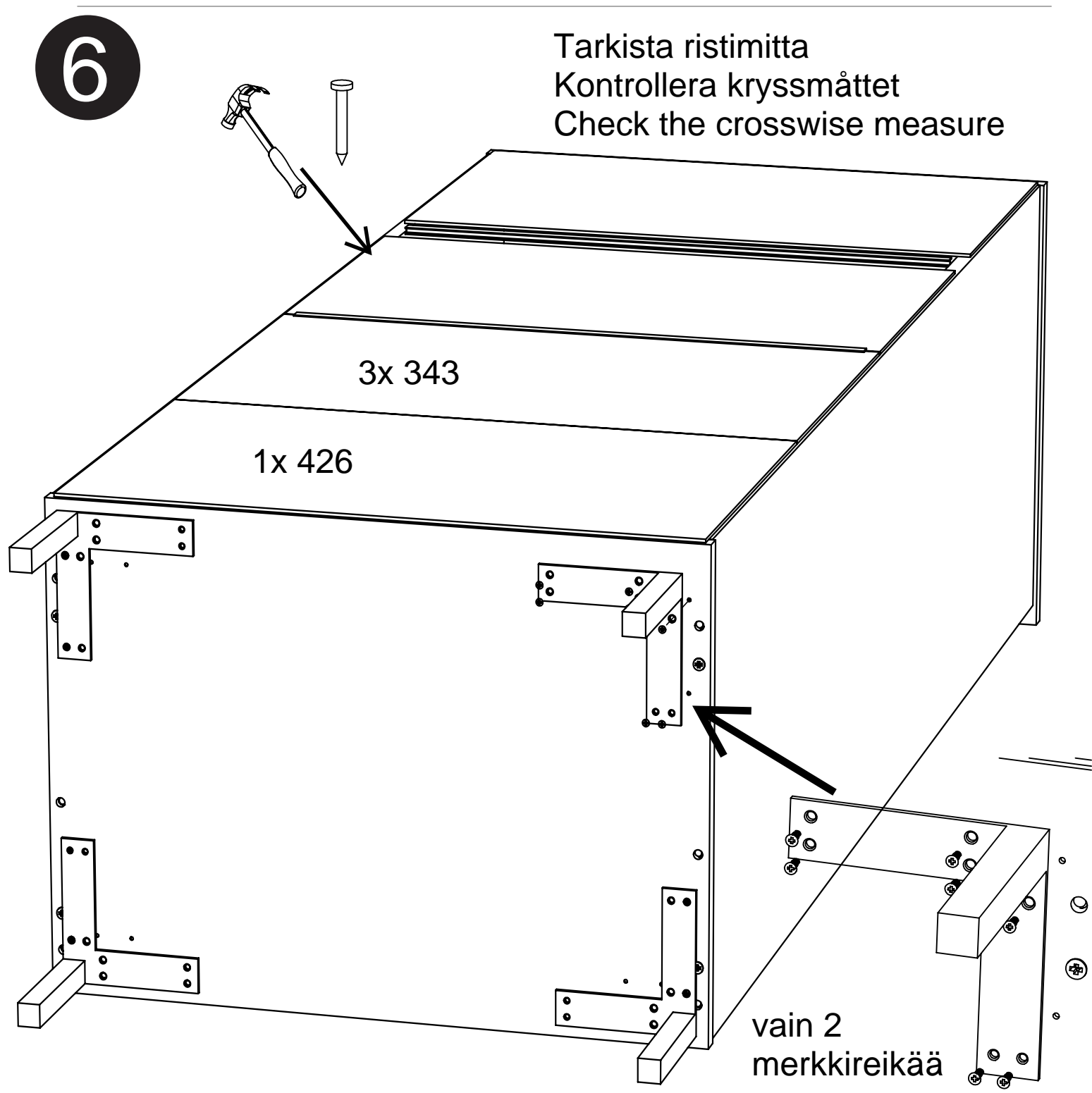



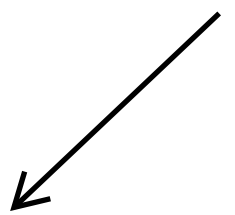

x 24

x 4



8

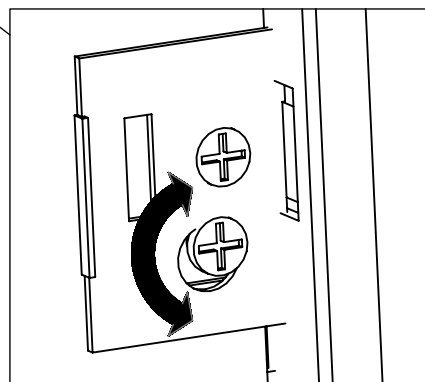
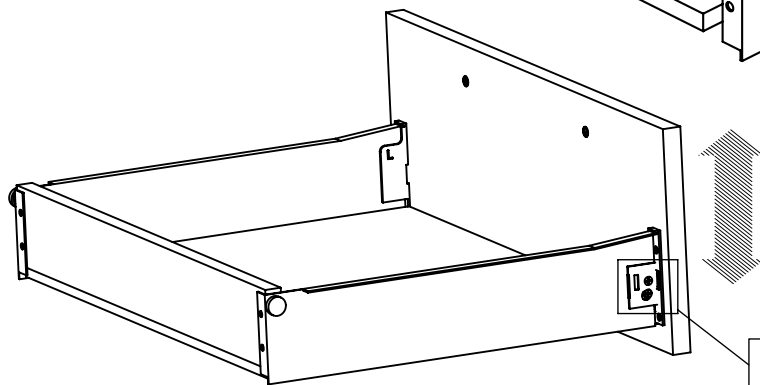
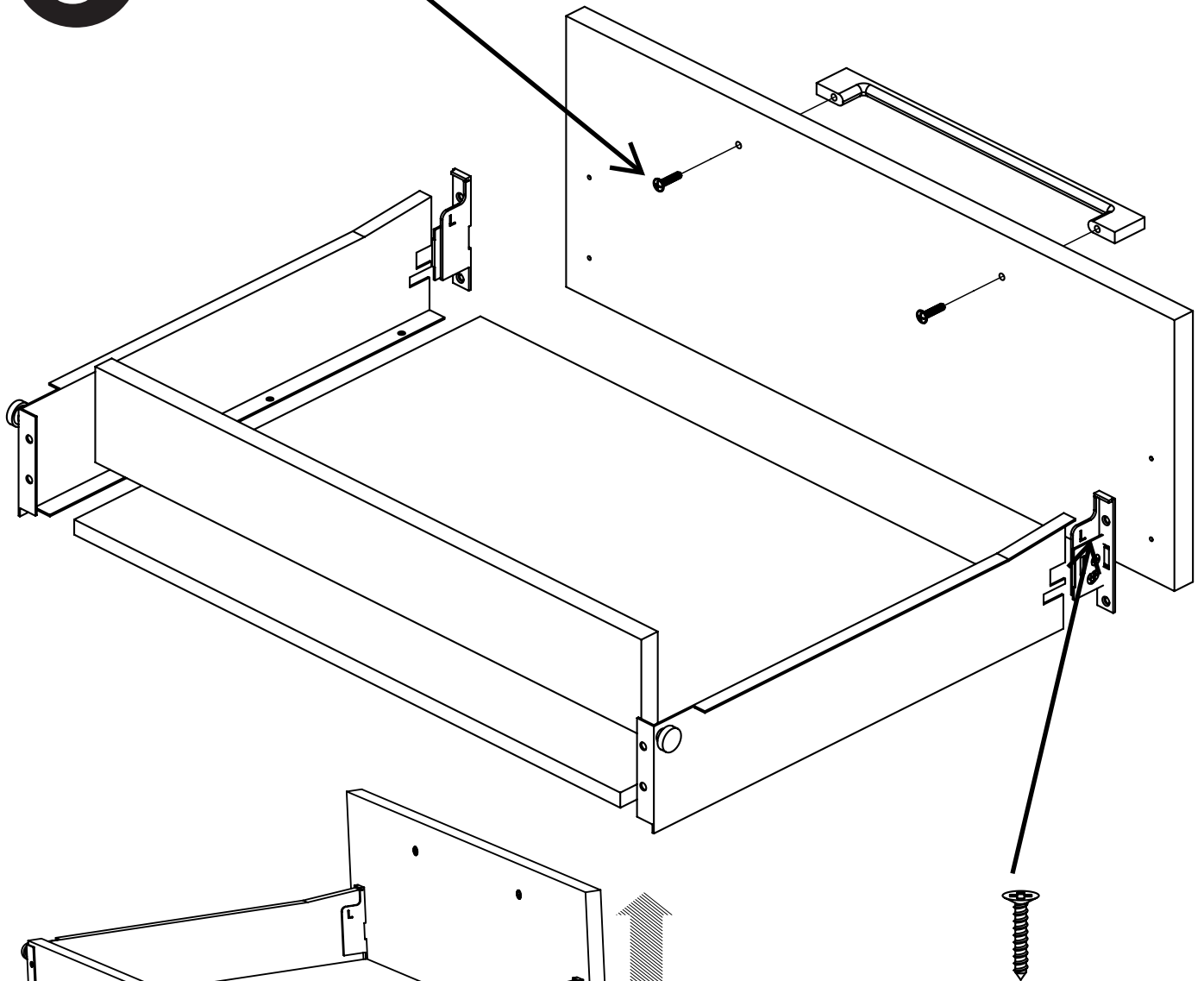
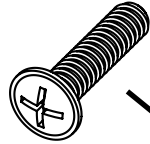

x 2

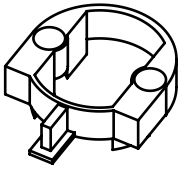

x 4



x 2

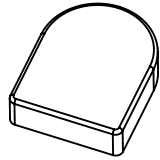

x 2



x 2



9

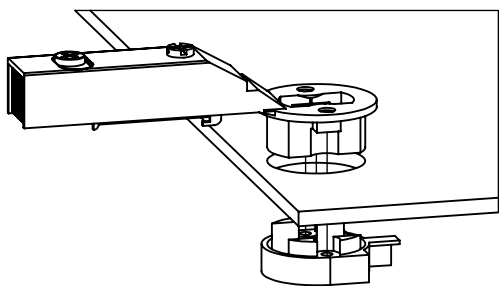
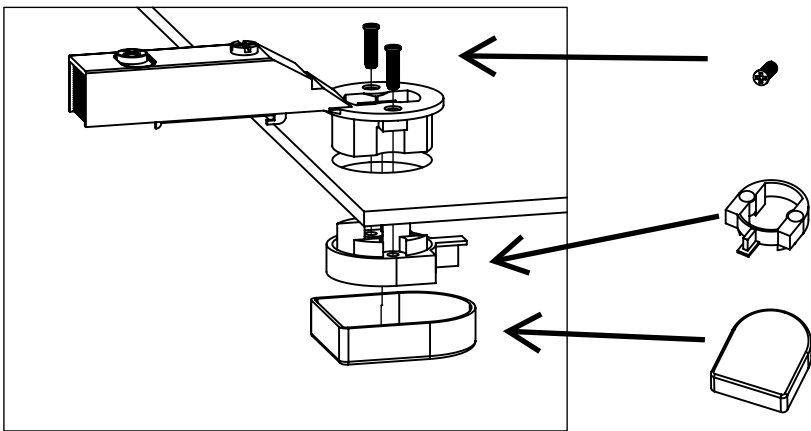
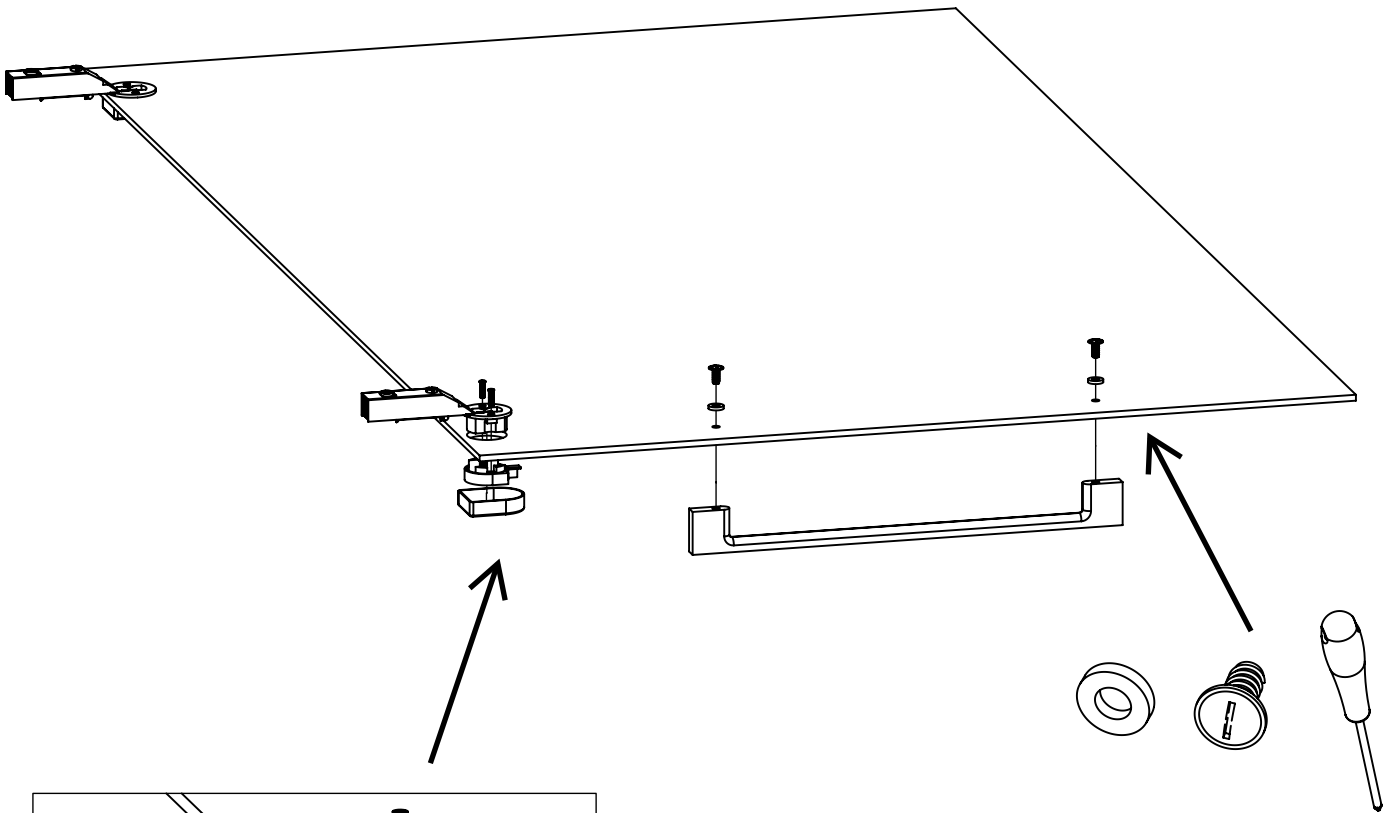

1

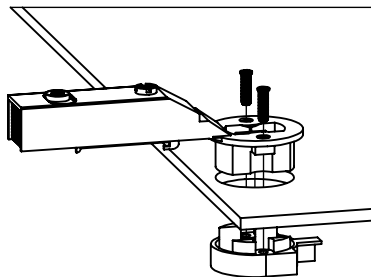

2

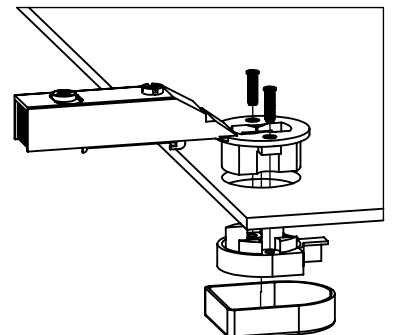

3



# Hiipakka

- Since 1951 -

## Made in Finland

Huonekalumme valmistetaan Pohjanmaalla, Kurikan Jurvassa. Nykyaikaisessa, pitkälle koneellistetussa tuotannossa työskentelee 30 kalustealan ammattilaista. Periaatteemme on toimia luotettavasti ja kannattavasti. Kehittyminen ja muutos koetaan positiivisesti ja on jatkuvuuden perusehto.

Hiipakka-kalusteiden pääraaka-aine on E1-luokan MFC-kalustelevy (Melamine Faced Chipboard), joka on tarkoitettu käytettäväksi kuivissa sisätiloissa ja on VTT:n hyväksymää. Melamiinipinnoite voidaan pyyhkiä nihkeällä ja on erittäin valonkestävä, joten kaluste pitää hyvin värinsä.

Huonekalumme toimitetaan laatikoihin pakattuna, jotta kuormittaisimme mahdollisimman vähän logistiikkaa. Pakatessa tuoteosat tarkastetaan. Porauksiin jää jonkin verran puupurua ja suosittelemme kalusteen kokoamista pakkauspahvin päällä tai muuten suojatulla alustalla, jotta puru ja muu puupöly on helppo kerätä pois. Kotisi turvallisuuden vuoksi yli 50 cm korkea huonekalu tulee kiinnittää seinään mukana tulevalla nauhalla, joka estää kaatumisen. Koska kotien seinämateriaalit vaihtelevat, jää seinäkiinnitysruuvi/naula asiakkaan hankittavaksi.

Mikäli sinulla on kysyttävää tuotteesta, voit olla yhteydessä suoraan meihin. Kehitämme tuotteitamme jatkuvasti ja olemme kiitollisia kaikesta asiakaspalautteesta. Palaute tulee perille nopeasti kotisivujemme kautta [www.hiipakka.net](http://www.hiipakka.net)

*Den huvudsakliga råvaran i Hiipakkas möbler är MFC-möbelskivor (Melamine Faced Chipboard) av klass E1. Dessa är avsedda att användas i torra utrymmen inomhus och har godkänts av Finlands statliga forskningscentral VTT. Melaminytan kan torkas av med en fuktig trasa och tack vare sin höga ljusbeständighet behåller möbeln färgen väl.*

*Vi levererar våra möbler omonterade, nedpackade i lådor för att minska transportererna. Produktdelarna kontrolleras i samband med nedpackningen. Det finns alltid kvar lite sågspån i borrhålen och därför rekommenderar vi att du monterar möbeln på förpackningskartongen eller på ett annat skyddat underlag. Då blir det enkelt att städa bort spån och annat trädamm.*

*Kontakta oss om du har några frågor om en produkt. Vi utvecklar hela tiden våra produkter och är tacksamma för all feedback från våra kunder. Dina kommentarer når oss snabbt via [www.hiipakka.net](http://www.hiipakka.net).*

**Jos sinulla on ongelmia tai kysyttävää tuotteesta, älä epäröi kysyä meiltä!  
Om du har problem eller frågor om produkten, tveka inte att fråga oss!  
If you have problems or questions regarding the product, do not hesitate to ask us!**

[www.hiipakka.net](http://www.hiipakka.net)

Puh / Tel / Phone:  
**+358 20 7689 500**

[info@ejh.fi](mailto:info@ejh.fi)